

Product Image

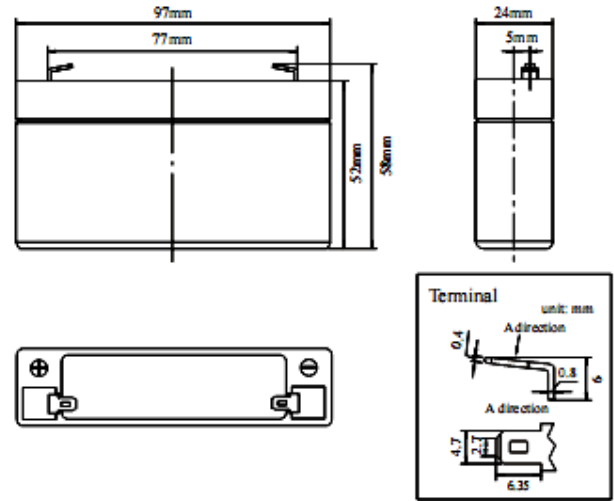

Product Dimensions



Characteristics

Nominal Voltage		6V
Nominal Capacity (20 hour rate)		0.5Ah
Capacity 25°C (77 °F)	10 hour rate (0.046A)	0.46Ah
	5 hour rate (0.09A)	0.44Ah
	1 hour rate (0.33A)	0.33Ah
Internal Resistance	Full Charged Battery 25 °C	≤46mΩ
Capacity affected by Temperature (10 hour)	40°C (104 °F)	102%
	25°C (77 °F)	100%
	0°C (32 °F)	85%
	-15°C (5 °F)	65%
Self-Discharge 25°C (77 °F) Capacity	after 3 month storage	90%
	after 6 month storage	80%
	after 12 month storage	62%
Charge (Constant Voltage) 25°C (77 °F)	Float	Initial Charging Current Less than 0.4A Voltage 6.8-6.9V
	Cycle	Initial Charging Current Less than 0.4A Voltage 7.2-7.5V

Packaging

Battery Dimensions	Length	97mm
	Width	24mm
	Height	53mm
	Total Height	58mm
Box Dimensions	Length	309mm
	Width	214mm
	Height	170mm
Quantity Per Box		40 pcs per box
Net weight Per Cell		0.25kg ±20g
Net weight Per Box		10kg
Gross Weight		10.4kg

Discharge Constant Current per Cell (Amperes at 77°F25°C)

F.V/Time	5min	10min	15min	30min	45min	1h	2h	3h	5h	8h	10h	20h
1.60V	4.29	2.86	2.15	1.43	1.00	0.86	0.54	0.37	0.25	0.16	0.14	0.072
1.65V	4.21	2.81	2.11	1.40	0.98	0.84	0.53	0.36	0.24	0.16	0.13	0.070
1.70V	4.13	2.76	2.07	1.38	0.96	0.83	0.52	0.35	0.24	0.16	0.13	0.069
1.75V	4.06	2.70	2.03	1.35	0.95	0.81	0.51	0.35	0.23	0.16	0.13	0.068
1.80V	3.90	2.60	1.96	1.30	0.91	0.78	0.49	0.33	0.22	0.15	0.12	0.065

Discharge Constant Power per Cell (Watts at 77°F 25°C)

F.V/Time	5min	10min	15min	30min	45min	1h	2h	3h	5h	8h	10h	20h
1.60V	8.26	5.51	4.14	2.75	1.93	1.65	1.03	0.71	0.47	0.32	0.26	0.14
1.65V	8.11	5.41	4.07	2.70	1.89	1.62	1.01	0.69	0.46	0.31	0.26	0.14
1.70V	7.96	5.31	3.99	2.65	1.86	1.59	0.99	0.68	0.45	0.31	0.25	0.13
1.75V	7.81	5.21	3.92	2.60	1.82	1.56	0.98	0.67	0.45	0.30	0.25	0.13
1.80V	7.51	5.01	3.77	2.50	1.75	1.50	0.94	0.64	0.43	0.29	0.24	0.13

Note The above data are average values, and can be obtained within 3 charge/discharge cycles. These are not minimum values. Cell and battery designs/specifications are subject to modification without notice. Contact **MCA** for the latest information.

Performance Characteristics



Battery Construction

Component	Positive plate	Negative plate	Container	Cover	Safety valve	Terminal	Separator	Electrolyte
Raw material	Lead dioxide	Lead	ABS	ABS	Si-Rubber	Lead	Fiberglass	Sulfuric acid