

**Product Image**

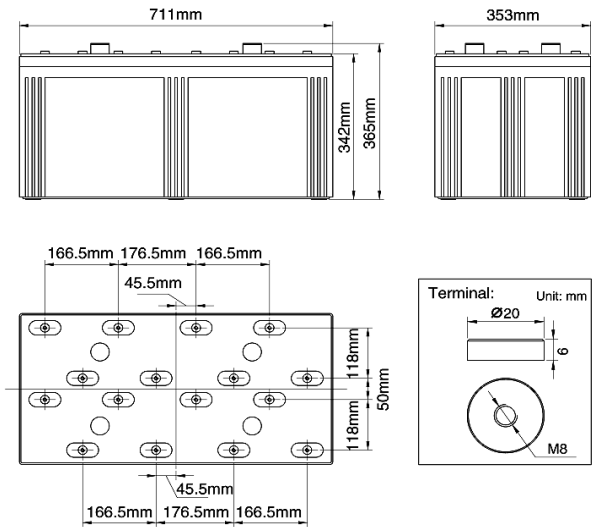

**Product Dimensions**



**Characteristics**

Nominal Voltage		2V
Nominal Capacity (10 hour rate)		2800Ah
Capacity 25°C (77 °F)	<b>20 hour rate (155.4A)</b>	<b>3108Ah</b>
	<b>5 hour rate (512.4A)</b>	<b>2584Ah</b>
	<b>1 hour rate (1862A)</b>	<b>1862Ah</b>
Internal Resistance	Full Charged Battery 25°C	≤0.08mΩ
Capacity affected by Temperature (10 hour )	40°C (104 °F)	102%
	25°C (77 °F)	100%
	0°C (32 °F)	85%
	-15°C (5 °F)	65%
Self-Discharge 25°C (77 °F) Capacity	after 3 month storage	90%
	after 6 month storage	80%
	after 12 month storage	62%
Charge (Constant Voltage) 25°C (77 °F)	Float	Initial Charging Current Less than 450A Voltage 2.23-2.27V
	Cycle	Initial Charging Current Less than 450A Voltage 2.33-2.37V

**Packaging**

Battery Dimensions	Length	711mm
	Width	353mm
	Height	341mm
	Total Height	382mm
Box Dimensions	Length	800mm
	Width	770mm
	Height	518mm
Quantity Per Box		2 PC per box
Net weight Per Cell		190 kg±1000g
Net weight Per Box		380kg
Gross Weight		380.5kg

**Discharge Constant Current (Amperes at 77°F/25°C)**

F.V/Time	5min	10min	15min	30min	45min	1h	2h	3h	5h	8h	10h	20h
1.60V	8382	5412	4488	2970	2211	1815	1155	825	561	370	330.0	174.9
1.65V	8230	5314	4406	2916	2171	1782	1134	810	551	363	324.0	171.7
1.70V	8077	5215	4325	2862	2131	1749	1113	795	541	356	318.0	168.5
1.75V	7925	5117	4243	2808	2090	1716	1092	780	530	349	312.0	165.4
1.80V	7620	4920	4080	2700	2010	1650	1050	750	510	336	300.0	159.0

**Discharge Constant Power (Watts at 77°F 25°C)**

F.V/Time	5min	10min	15min	30min	45min	1h	2h	3h	5h	8h	10h	20h
1.60V	16135	10418	8639	5717	4256	3494	2223	1588	1080	711	635.3	336.7
1.65V	15842	10229	8482	5613	4179	3430	2183	1559	1060	699	623.7	330.6
1.70V	15549	10039	8325	5509	4101	3367	2143	1530	1041	686	612.2	324.4
1.75V	15255	9850	8168	5405	4024	3303	2102	1502	1021	673	600.6	318.3
1.80V	14669	9471	7854	5198	3869	3176	2021	1444	982	647	577.5	306.1

**Note** The above data are average values, and can be obtained within 3 charge/discharge cycles. These are not minimum values. Cell and battery designs/specifications are subject to modification without notice. Contact **CTD** for the latest information.

**Performance Characteristics**

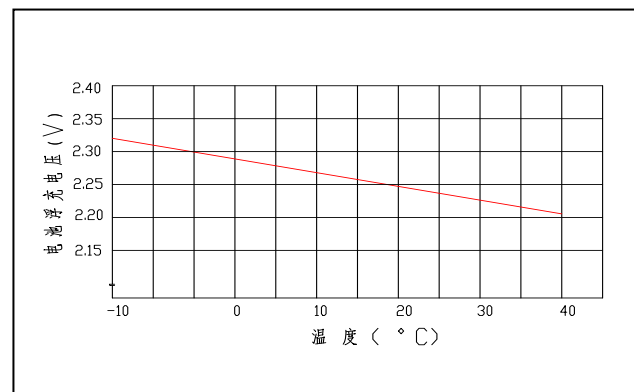
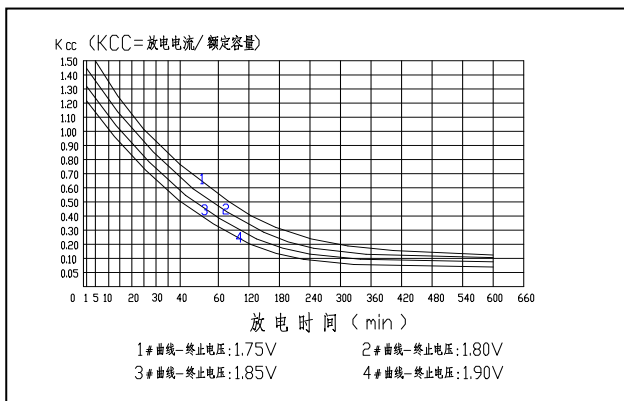
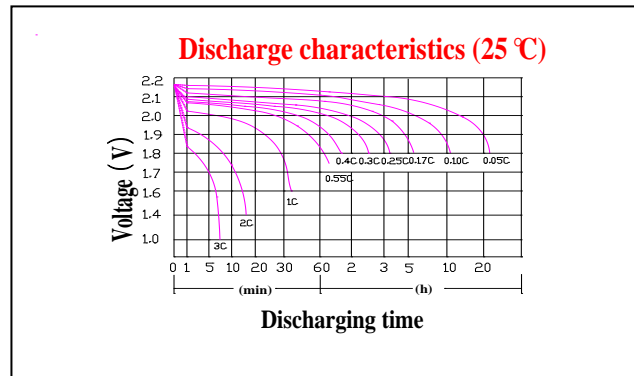
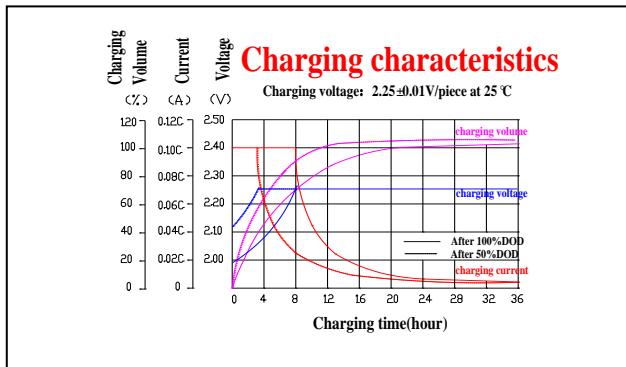
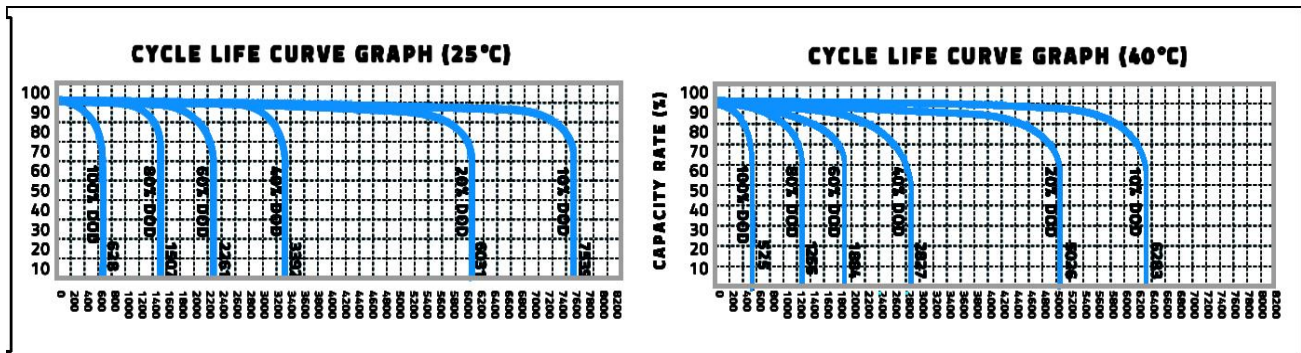
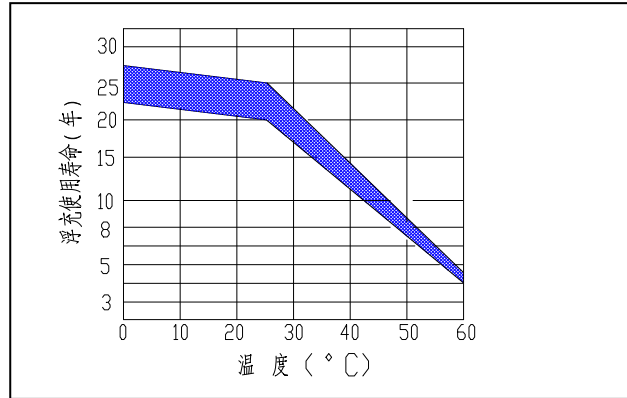
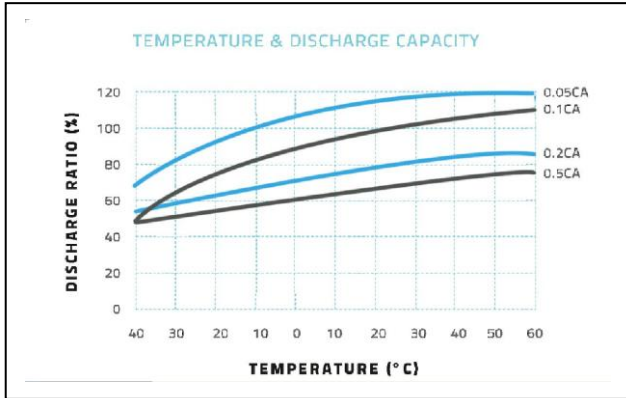

**Battery Construction**

Component	Positive plate	Negative plate	Container	Cover	Safety valve	Terminal	Separator	Electrolyte
Raw material	Lead dioxide	Lead	ABS	ABS	Si-Rubber	Copper	Fiberglass	Silicon