

**Product Image**

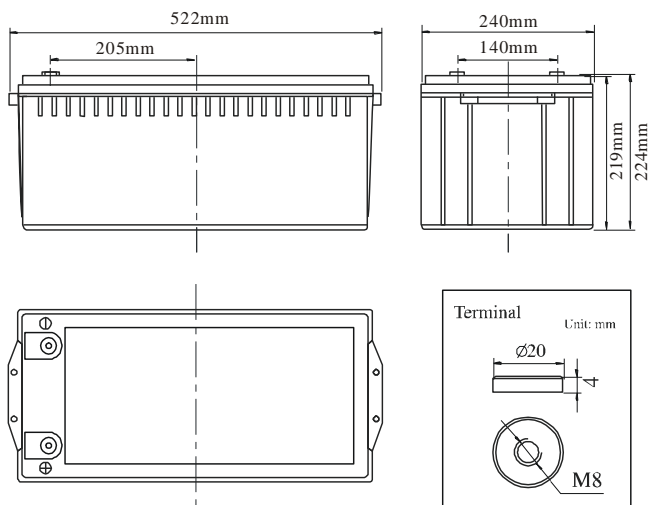

**Product Dimensions**



**Characteristics**

|  |                           |  |
|--|---------------------------|--|
| Nominal Voltage                                    |                           | 12V  |
| Nominal Capacity (10 hour rate)                    |                           | 200Ah  |
| Capacity<br>25°C (77 °F)                           | 20 hour rate (11.1A)      | 222Ah  |
|  | 5 hour rate (36.6A)       | 183Ah  |
|  | 1 hour rate (133A)        | 133Ah  |
| Internal Resistance                                | Full Charged Battery 25°C | ≤2.5mΩ   |
| Capacity affected by<br>Temperature<br>(10 hour )  | 40°C (104 °F)             | 102%   |
|  | 25°C (77 °F)              | 100%   |
|  | 0°C (32 °F)               | 85%  |
|  | -15°C (5 °F)              | 65%  |
| Self-Discharge<br>25°C (77 °F)<br>Capacity         | after 3 month storage     | 90%  |
|  | after 6 month storage     | 80%  |
|  | after 12 month storage    | 62%  |
| Charge<br>(Constant<br>Voltage)<br>25°C<br>(77 °F) | Float                     | Initial Charging Current Less than 40A<br>Voltage 13.6-13.8V |
|  | Cycle                     | Initial Charging Current Less than 40A<br>Voltage 14.4-14.9V |

**Packaging**

|                       |                 |              |
|-----------------------|-----------------|--------------|
| Battery<br>Dimensions | Length          | 522mm        |
|                       | Width           | 240mm        |
|                       | Height          | 219mm        |
|                       | Total<br>Height | 224mm        |
| Box<br>Dimensions     | Length          | 537mm        |
|                       | Width           | 255mm        |
|                       | Height          | 299mm        |
| Quantity Per Box      |                 | 1 PC per box |
| Net weight Per Cell   |                 | 53.5 kg±500g |
| Net weight Per Box    |                 | 53.5kg       |
| Gross Weight          |                 | 53.8kg       |

**Discharge Constant Current per Cell (Amperes at 77°F 25°C)**

| F.V/Time | 5min  | 10min | 15min | 30min | 45min | 1h    | 2h   | 3h   | 5h   | 8h   | 10h  | 20h  |
|----------|-------|-------|-------|-------|-------|-------|------|------|------|------|------|------|
| 1.60V    | 577.9 | 371.6 | 309.5 | 206.4 | 148.1 | 132.0 | 81.8 | 55.0 | 37.4 | 24.6 | 22.0 | 12.1 |
| 1.65V    | 567.4 | 364.8 | 303.9 | 202.6 | 145.4 | 129.6 | 80.4 | 54.0 | 36.7 | 24.2 | 21.6 | 11.9 |
| 1.70V    | 556.9 | 358.1 | 298.3 | 198.9 | 142.7 | 127.2 | 78.9 | 53.0 | 36.0 | 23.7 | 21.2 | 11.7 |
| 1.75V    | 546.4 | 351.3 | 292.7 | 195.1 | 140.0 | 124.8 | 77.4 | 52.0 | 35.4 | 23.3 | 20.8 | 11.4 |
| 1.80V    | 525.4 | 337.8 | 281.4 | 187.6 | 134.6 | 120.0 | 74.4 | 50.0 | 34.0 | 22.4 | 20.0 | 11.0 |

**Discharge Constant Power per Cell (Watts at 77°F 25°C)**

| F.V/Time | 5min   | 10min | 15min | 30min | 45min | 1h    | 2h    | 3h    | 5h   | 8h   | 10h  | 20h  |
|----------|--------|-------|-------|-------|-------|-------|-------|-------|------|------|------|------|
| 1.60V    | 1112.5 | 715.3 | 595.9 | 397.2 | 285.0 | 254.1 | 157.5 | 105.9 | 72.0 | 47.4 | 42.4 | 23.3 |
| 1.65V    | 1092.3 | 702.3 | 585.0 | 390.0 | 279.8 | 249.5 | 154.7 | 104.0 | 70.7 | 46.6 | 41.6 | 22.9 |
| 1.70V    | 1072.1 | 689.3 | 574.2 | 382.8 | 274.7 | 244.9 | 151.8 | 102.0 | 69.4 | 45.7 | 40.8 | 22.4 |
| 1.75V    | 1051.9 | 676.3 | 563.4 | 375.6 | 269.5 | 240.2 | 148.9 | 100.1 | 68.1 | 44.8 | 40.0 | 22.0 |
| 1.80V    | 1011.4 | 650.3 | 541.7 | 361.1 | 259.1 | 231.0 | 143.2 | 96.3  | 65.5 | 43.1 | 38.5 | 21.2 |

**Note** The above data are average values, and can be obtained within 3 charge/discharge cycles. These are not minimum values. Cell and battery designs/specifications are subject to modification without notice. Contact **US** for the latest information.

**Performance Characteristics**

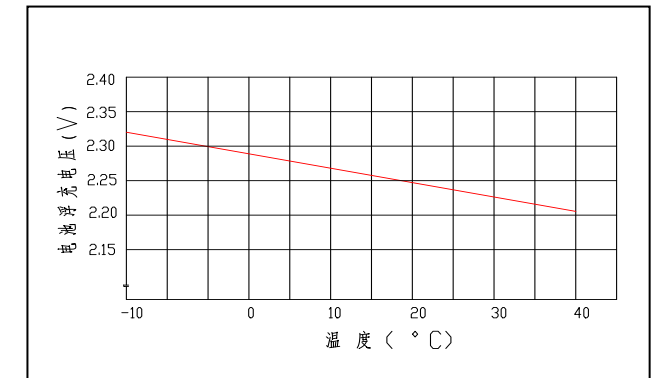
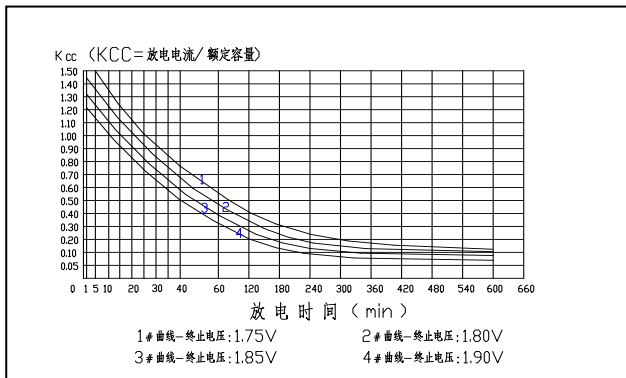
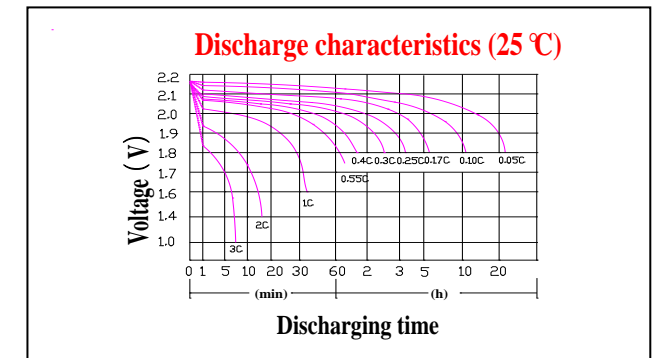
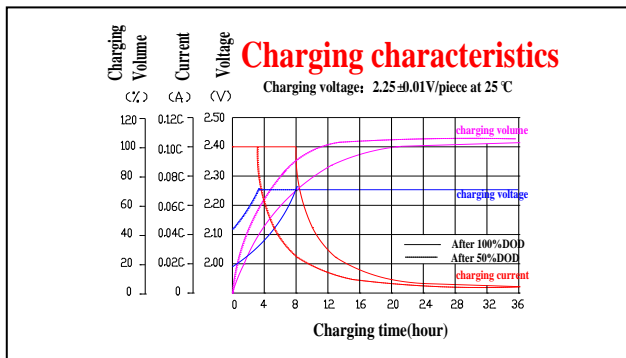
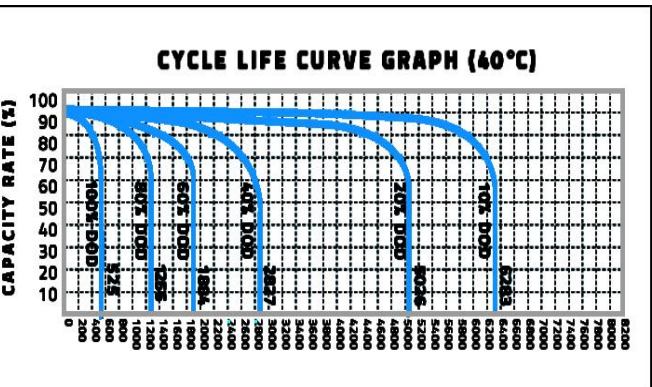
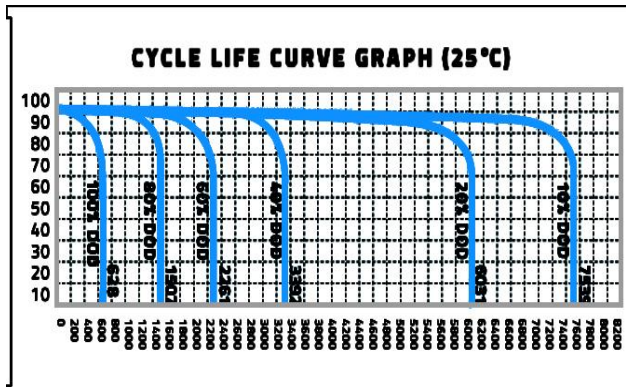
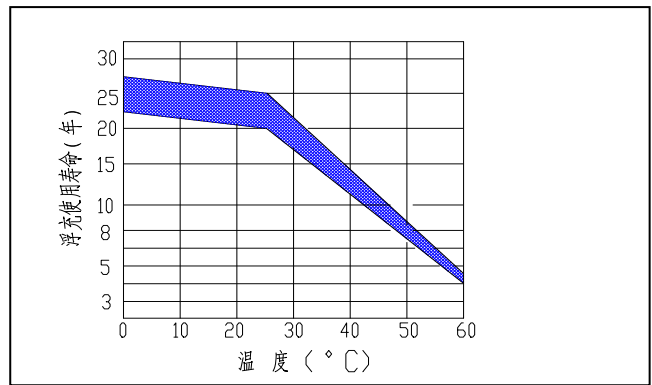
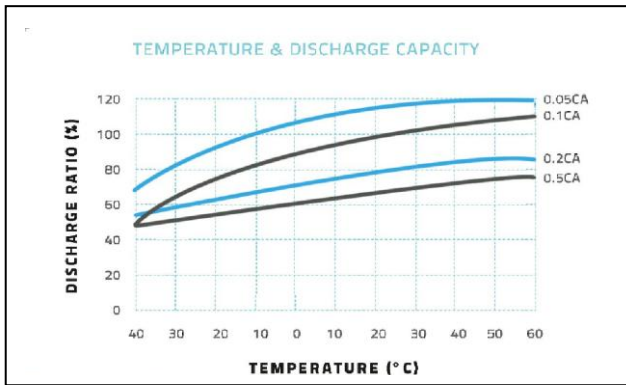

**Battery Construction**

| Component    | Positive plate | Negative plate | Container | Cover | Safety valve | Terminal | Separator  | Electrolyte |
|--------------|----------------|----------------|-----------|-------|--------------|----------|------------|-------------|
| Raw material | Lead dioxide   | Lead           | ABS       | ABS   | Si-Rubber    | Copper   | Fiberglass | Nano        |