

Product Image

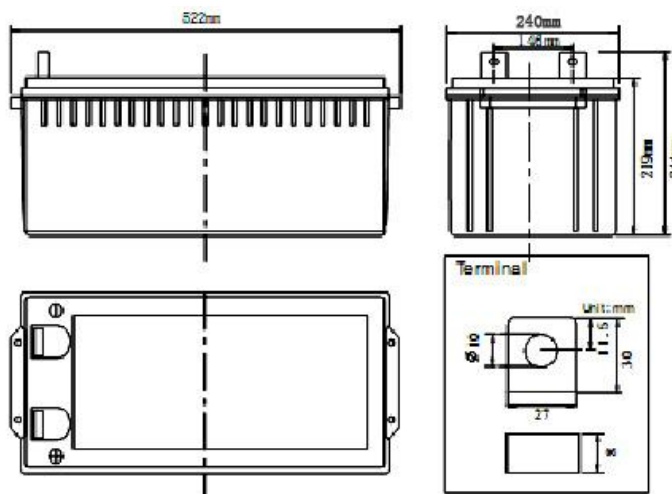

Product Dimensions



Characteristics

| | | |
|--|---------------------------|--|
| Nominal Voltage | | 12V |
| Nominal Capacity (10 hour rate) | | 210Ah |
| Capacity 25°C (77 °F) | 20 hour rate (11.7A) | 233.1Ah |
| | 5 hour rate (38.4A) | 192.2Ah |
| | 1 hour rate (139.7A) | 139.7Ah |
| Internal Resistance | Full Charged Battery 25°C | ≤2.5mΩ |
| Capacity affected by Temperature (10 hour) | 40°C (104 °F) | 102% |
| | 25°C (77 °F) | 100% |
| | 0°C (32 °F) | 85% |
| | -15°C (5 °F) | 65% |
| Self-Discharge 25°C (77 °F) Capacity | after 3 month storage | 90% |
| | after 6 month storage | 80% |
| | after 12 month storage | 62% |
| Charge (Constant Voltage) 25°C (77 °F) | Float | Initial Charging Current Less than 50A Voltage 13.6-13.8V |
| | Cycle | Initial Charging Current Less than 50A Voltage 14.4-14.9V |

Packaging

| | | |
|-----------------------|-----------------|--------------|
| Battery Dimensions | Length | 522mm |
| | Width | 240mm |
| | Height | 219mm |
| | Total Height | 244mm |
| Box Dimensions | Length | 537mm |
| | Width | 255mm |
| | Height | 299mm |
| Quantity Per Box | | 1 PC per box |
| Net weight Per Cell | | 57.0 kg±500g |
| Net weight Per Box | | 57.0kg |
| Gross Weight | | 57.5kg |

Discharge Constant Current per Cell (Amperes at 77°F25°C)

| F.V/Time | 5min | 10min | 15min | 30min | 45min | 1h | 2h | 3h | 5h | 8h | 10h | 20h |
|----------|-------|-------|-------|-------|-------|-------|------|------|------|------|------|------|
| 1.60V | 577.9 | 371.6 | 309.5 | 206.4 | 148.1 | 132.0 | 81.8 | 55.0 | 37.4 | 24.6 | 22.0 | 12.1 |
| 1.65V | 567.4 | 364.8 | 303.9 | 202.6 | 145.4 | 129.6 | 80.4 | 54.0 | 36.7 | 24.2 | 21.6 | 11.9 |
| 1.70V | 556.9 | 358.1 | 298.3 | 198.9 | 142.7 | 127.2 | 78.9 | 53.0 | 36.0 | 23.7 | 21.2 | 11.7 |
| 1.75V | 546.4 | 351.3 | 292.7 | 195.1 | 140.0 | 124.8 | 77.4 | 52.0 | 35.4 | 23.3 | 20.8 | 11.4 |
| 1.80V | 525.4 | 337.8 | 281.4 | 187.6 | 134.6 | 120.0 | 74.4 | 50.0 | 34.0 | 22.4 | 20.0 | 11.0 |

Discharge Constant Power per Cell (Watts at 77°F 25°C)

| F.V/Time | 5min | 10min | 15min | 30min | 45min | 1h | 2h | 3h | 5h | 8h | 10h | 20h |
|----------|--------|-------|-------|-------|-------|-------|-------|-------|------|------|------|------|
| 1.60V | 1112.5 | 715.3 | 595.9 | 397.2 | 285.0 | 254.1 | 157.5 | 105.9 | 72.0 | 47.4 | 42.4 | 23.3 |
| 1.65V | 1092.3 | 702.3 | 585.0 | 390.0 | 279.8 | 249.5 | 154.7 | 104.0 | 70.7 | 46.6 | 41.6 | 22.9 |
| 1.70V | 1072.1 | 689.3 | 574.2 | 382.8 | 274.7 | 244.9 | 151.8 | 102.0 | 69.4 | 45.7 | 40.8 | 22.4 |
| 1.75V | 1051.9 | 676.3 | 563.4 | 375.6 | 269.5 | 240.2 | 148.9 | 100.1 | 68.1 | 44.8 | 40.0 | 22.0 |
| 1.80V | 1011.4 | 650.3 | 541.7 | 361.1 | 259.1 | 231.0 | 143.2 | 96.3 | 65.5 | 43.1 | 38.5 | 21.2 |

Note The above data are average values, and can be obtained within 3 charge/discharge cycles. These are not minimum values. Cell and battery designs/specifications are subject to modification without notice. Contact **US** for the latest information.

Performance Characteristics

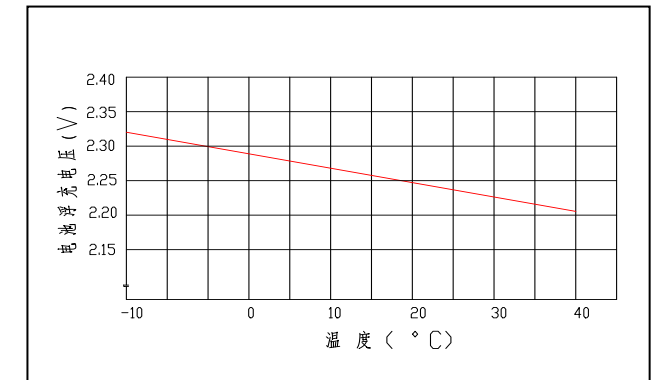
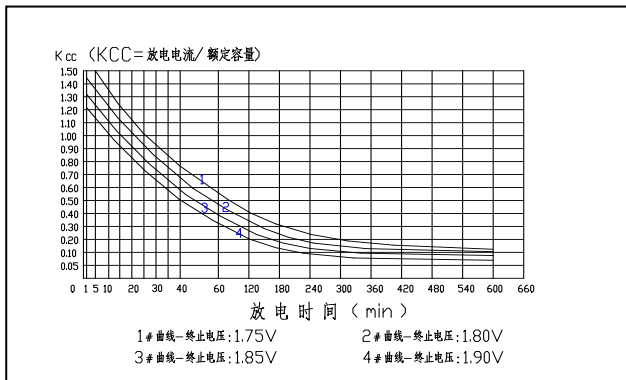
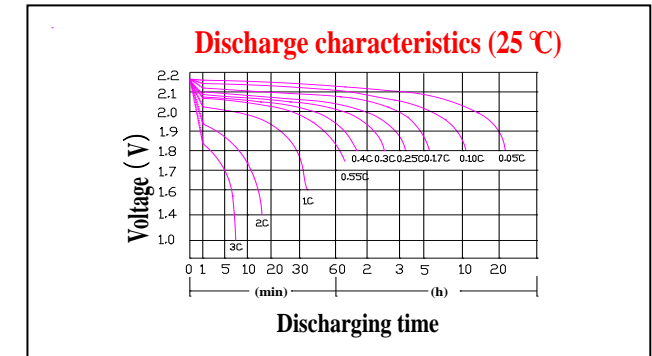
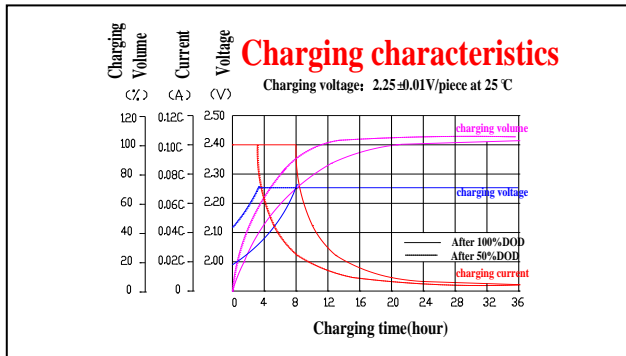
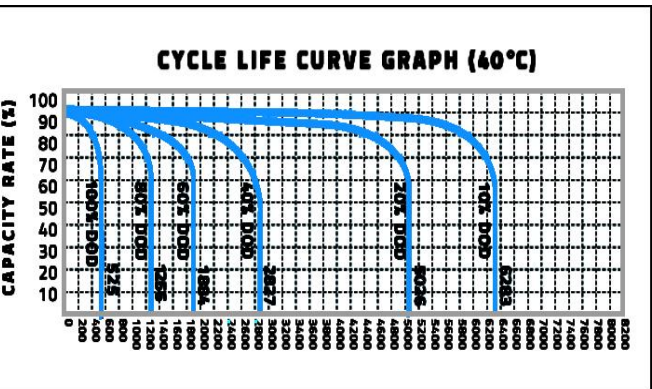
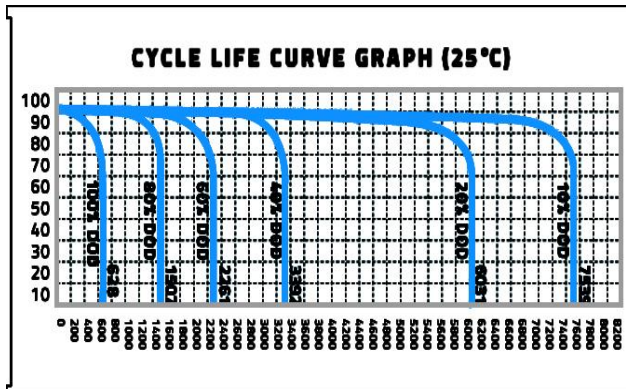
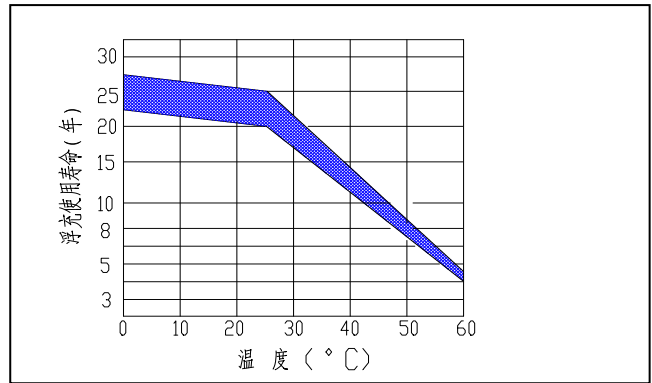
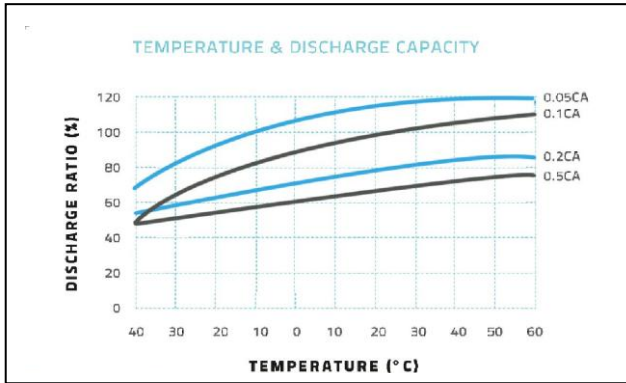

Battery Construction

| Component | Positive plate | Negative plate | Container | Cover | Safety valve | Terminal | Separator | Electrolyte |
|--------------|----------------|----------------|-----------|-------|--------------|----------|------------|-------------|
| Raw material | Lead dioxide | Lead | ABS | ABS | Si-Rubber | Copper | Fiberglass | Nano |