

Product Image

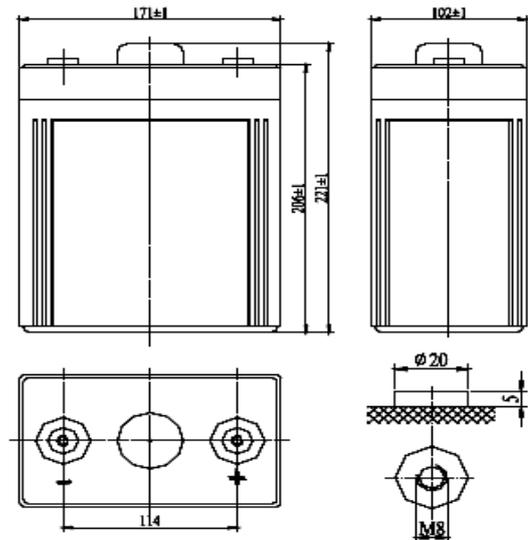

Product Dimensions



Characteristics

Nominal Voltage		2V
Nominal Capacity (10 hour rate)		150Ah
Capacity 25°C (77 °F)	20 hour rate (7.95A)	159Ah
	5 hour rate (26.5A)	132.5Ah
	1 hour rate (82.5A)	82.5Ah
Internal Resistance	Full Charged Battery 25°C	≤1.5mΩ
Capacity affected by Temperature (10 hour)	40°C (104 °F)	102%
	25°C (77 °F)	100%
	0°C (32 °F)	85%
	-15°C (5 °F)	65%
Self-Discharge 25°C (77 °F) Capacity	after 3 month storage	90%
	after 6 month storage	80%
	after 12 month storage	62%
Charge (Constant Voltage) 25°C (77 °F)	Float	Initial Charging Current Less than 22.5A Voltage 2.24-2.28V
	Cycle	Initial Charging Current Less than 22.5A Voltage 2.33-2.37V

Packaging

Battery Dimensions	Length	171mm
	Width	102mm
	Height	206mm
	Total Height	226mm
Box Dimensions	Length	224mm
	Width	187mm
	Height	261mm
Quantity Per Box		2 PC per box
Net weight Per Cell		8.8 kg ±200g
Net weight Per Box		17.6kg
Gross Weight		18.0kg

Discharge Constant Current per Cell (Amperes at 77°F/25°C)

F.V/Time	5min	10min	15min	30min	45min	1h	2h	3h	5h	8h	10h	20h
1.60V	419	271	224	149	111	91	58	41	28	18	16.5	8.7
1.65V	411	266	220	146	109	89	57	41	28	18	16.2	8.6
1.70V	404	261	216	143	107	87	56	40	27	18	15.9	8.4
1.75V	396	256	212	140	105	86	55	39	27	17	15.6	8.3
1.80V	381	246	204	135	101	83	53	38	26	17	15.0	8.0

Discharge Constant Power per Cell (Watts at 77°F 25°C)

F.V/Time	5min	10min	15min	30min	45min	1h	2h	3h	5h	8h	10h	20h
1.60V	807	521	432	286	213	175	111	79	54	36	31.8	16.8
1.65V	792	511	424	281	209	172	109	78	53	35	31.2	16.5
1.70V	777	502	416	275	205	168	107	77	52	34	30.6	16.2
1.75V	763	492	408	270	201	165	105	75	51	34	30.0	15.9
1.80V	733	474	393	260	193	159	101	72	49	32	28.9	15.3

Note The above data are average values, and can be obtained within 3 charge/discharge cycles. These are not minimum values. Cell and battery designs/specifications are subject to modification without notice. Contact **US** for the latest information.

Performance Characteristics

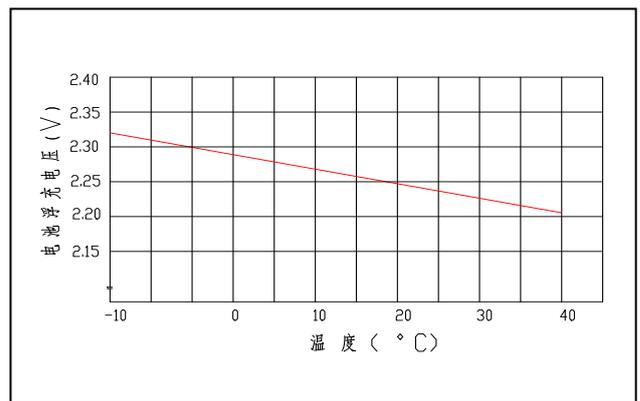
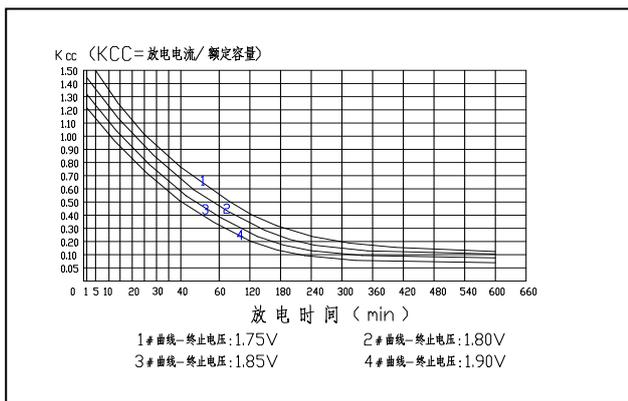
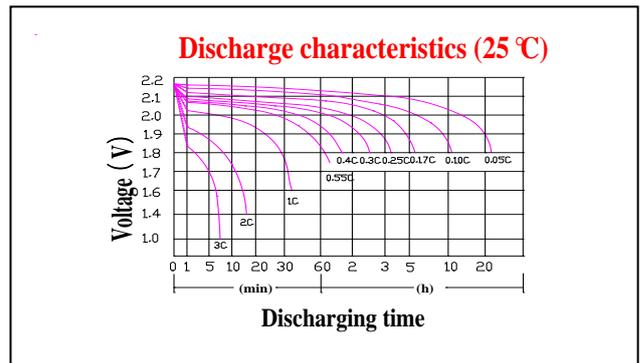
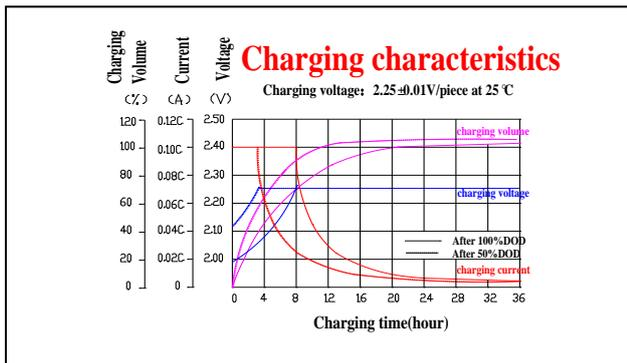
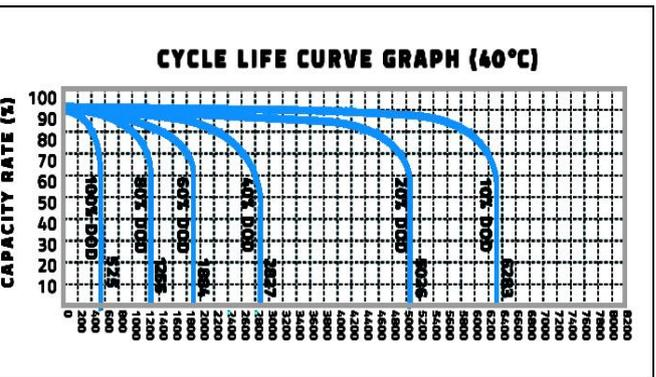
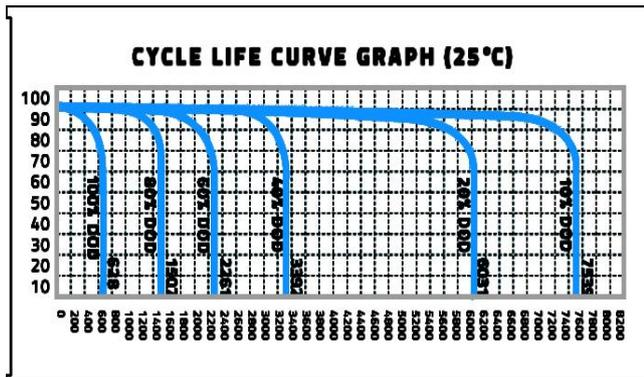
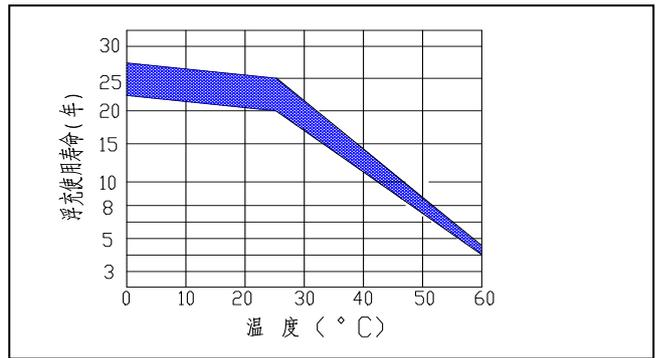
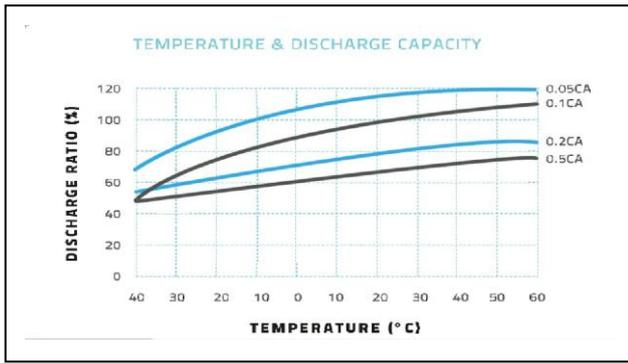

Battery Construction

Component	Positive plate	Negative plate	Container	Cover	Safety valve	Terminal	Separator	Electrolyte
Raw material	Lead dioxide	Lead	ABS	ABS	Si-Rubber	Copper	Fiberglass	Lead