

**Product Image**

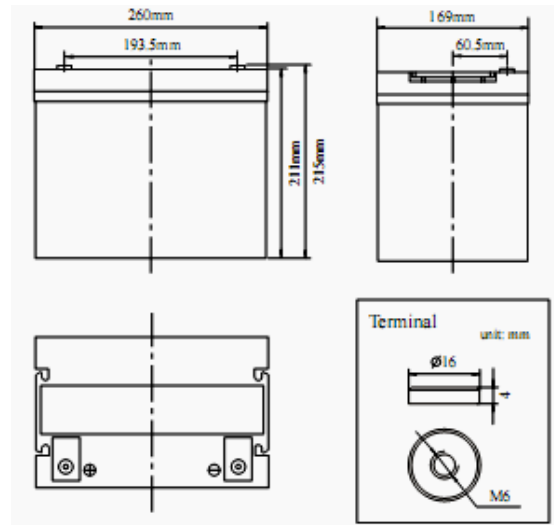

**Product Dimensions**



**Characteristics**

Nominal Voltage		12V
Nominal Capacity (10 hour rate)		88Ah
Capacity 25°C (77 °F)	20 hour rate (4.9A)	97.7Ah
	5 hour rate (16.1A)	80.5Ah
	1 hour rate (58.5A)	58.5Ah
Internal Resistance	Full Charged Battery 25°C	≤5.0mΩ
Capacity affected by Temperature (10 hour )	40°C (104 °F)	102%
	25°C (77 °F)	100%
	0°C (32 °F)	85%
	-15°C (5 °F)	65%
Self-Discharge 25°C (77 °F) Capacity	after 3 month storage	90%
	after 6 month storage	80%
	after 12 month storage	62%
Charge (Constant Voltage) 25°C (77 °F)	Float	Initial Charging Current Less than 25.0A Voltage 13.6-13.8V
	Cycle	Initial Charging Current Less than 25.0A Voltage 14.4-14.9V

**Packaging**

Battery Dimensions	Length	260mm
	Width	169mm
	Height	211mm
	Total Height	215mm
Box Dimensions	Length	275mm
	Width	183mm
	Height	272mm
Quantity Per Box		1 PC per box
Net weight Per Cell		27.0 kg±3%
Net weight Per Box		27.0kg
Gross Weight		27.5kg

**Discharge Constant Current per Cell (Amperes at 77°F/25°C)**

F.V/Time	5min	10min	15min	30min	45min	1h	2h	3h	5h	8h	10h	20h
1.60V	235.4	156.8	118.2	73.5	52.8	46.6	28.4	20.8	13.4	8.2	7.28	4.04
1.65V	217.0	144.6	113.3	71.6	51.3	45.3	27.9	20.4	13.2	8.1	7.21	4.00
1.70V	220.7	147.0	108.3	69.6	49.9	44.1	27.3	20.0	13.0	8.0	7.14	3.96
1.75V	194.9	129.9	103.4	67.6	48.5	42.8	26.7	19.5	12.8	7.9	7.07	3.92
1.80V	183.9	122.5	98.5	65.7	47.1	41.6	26.0	19.0	12.6	7.8	7.00	3.89

**Discharge Constant Power per Cell (Watts at 77°F 25°C)**

F.V/Time	5min	10min	15min	30min	45min	1h	2h	3h	5h	8h	10h	20h
1.60V	439.0	292.4	220.4	137.2	98.4	86.9	52.9	38.7	24.9	15.2	13.6	7.5
1.65V	404.7	269.6	211.2	133.5	95.8	84.5	52.0	38.0	24.6	15.1	13.4	7.5
1.70V	411.5	274.2	202.1	129.8	93.1	82.2	51.0	37.3	24.2	14.9	13.3	7.4
1.75V	363.5	242.2	192.9	126.1	90.5	79.9	49.8	36.4	23.9	14.8	13.2	7.3
1.80V	343.0	228.5	183.7	122.5	87.9	77.5	48.6	35.5	23.5	14.6	13.1	7.2

**Note** The above data are average values, and can be obtained within 3 charge/discharge cycles. These are not minimum values. Cell and battery designs/specifications are subject to modification without notice. Contact **US** for the latest information.

**Performance Characteristics**

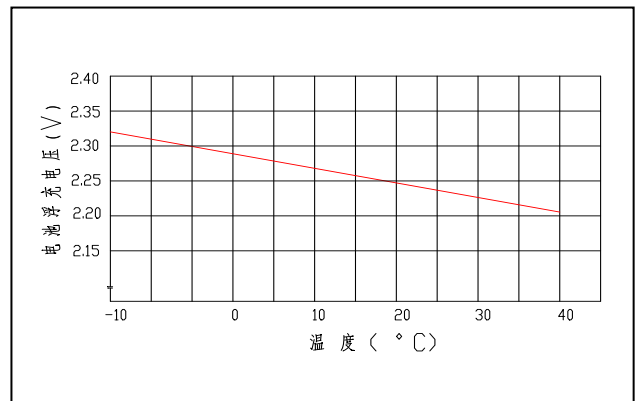
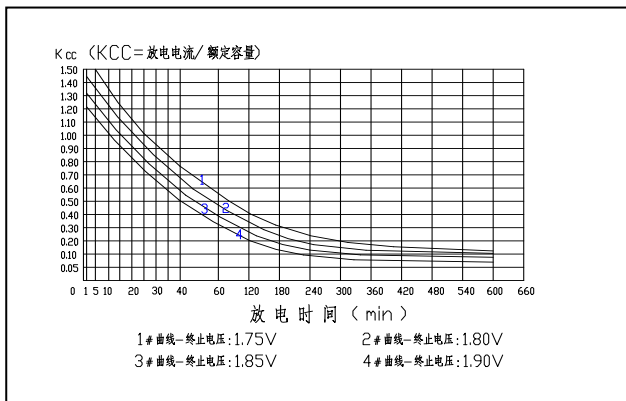
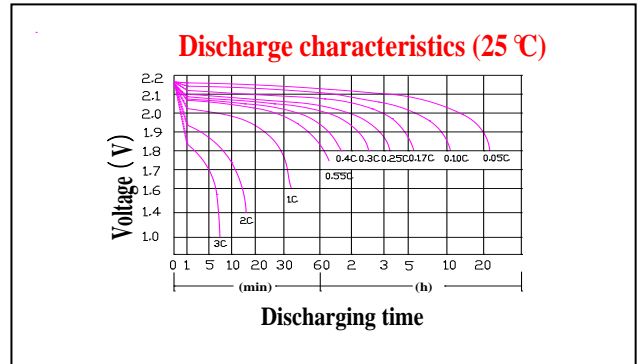
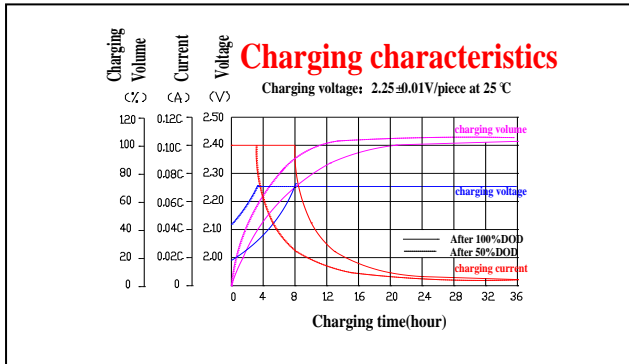
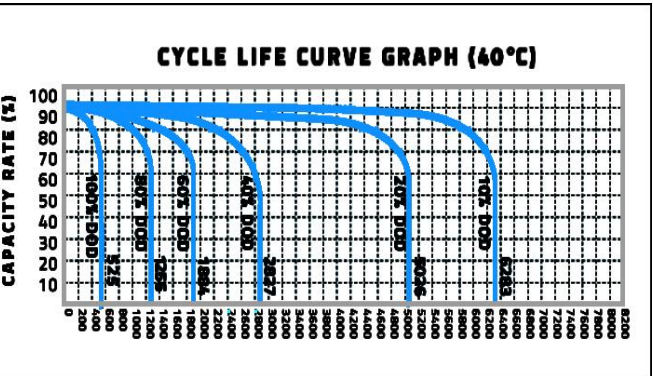
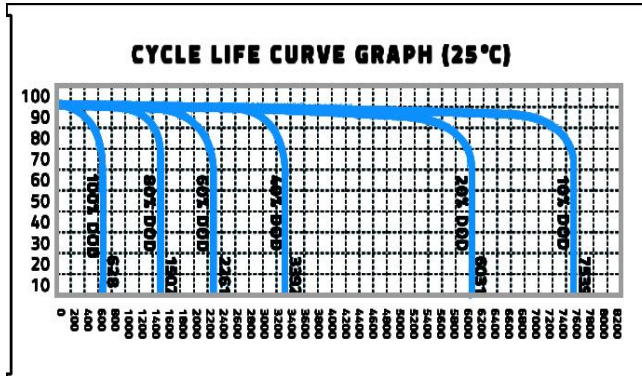
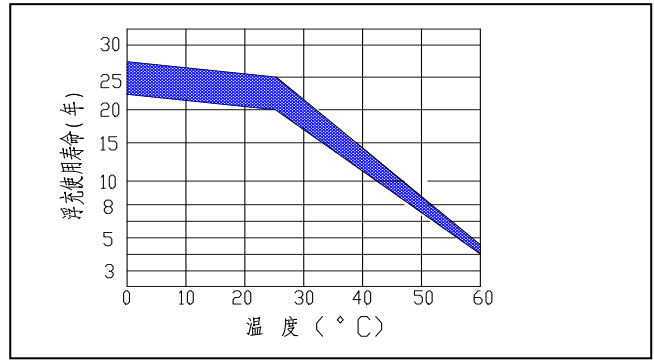
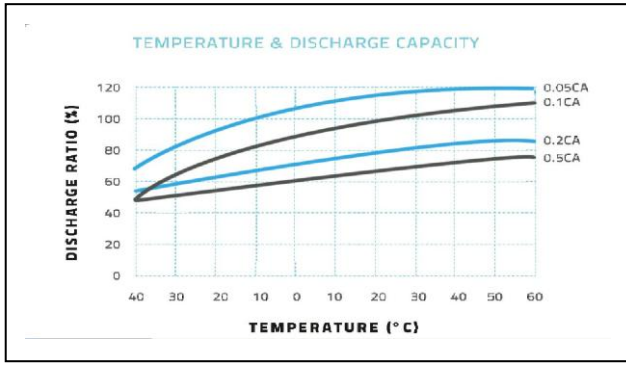

**Battery Construction**

Component	Positive plate	Negative plate	Container	Cover	Safety valve	Terminal	Separator	Electrolyte
Raw material	Lead dioxide	Lead	ABS	ABS	Si-Rubber	Copper	Fiberglass	Lead