

Product Image

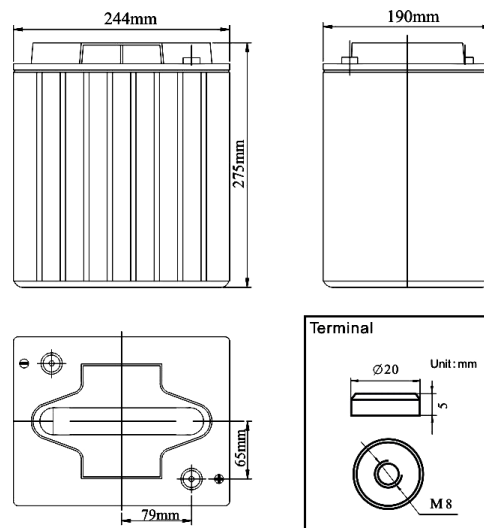

Product Dimensions



Characteristics

| | | |
|--|---------------------------|---|
| Nominal Voltage | | 6V |
| Nominal Capacity (20 hour rate) | | 225Ah |
| Capacity 25°C (77 °F) | 10 hour rate (12.5A) | 249.8Ah |
| | 5 hour rate (41.2A) | 205.9Ah |
| | 1 hour rate (149.6A) | 149.6Ah |
| Internal Resistance | Full Charged Battery 25°C | ≤2.7mΩ |
| Capacity affected by Temperature (10 hour) | 40°C (104 °F) | 102% |
| | 25°C (77 °F) | 100% |
| | 0°C (32 °F) | 85% |
| | -15°C (5 °F) | 65% |
| Self-Discharge 25°C (77 °F) Capacity | after 3 month storage | 90% |
| | after 6 month storage | 80% |
| | after 12 month storage | 62% |
| Charge (Constant Voltage) 25°C (77 °F) | Float | Initial Charging Current Less than 45A Voltage 6.8-6.9V |
| | Cycle | Initial Charging Current Less than 45A Voltage 7.2-7.45V |

Packaging

| | | |
|-----------------------|-----------------|--------------|
| Battery Dimensions | Length | 244mm |
| | Width | 190mm |
| | Height | 275mm |
| | Total Height | 275mm |
| Box Dimensions | Length | 258mm |
| | Width | 201mm |
| | Height | 335mm |
| Quantity Per Box | | 1 PC per box |
| Net weight Per Cell | | 31.0 kg±200g |
| Net weight Per Box | | 31.0kg |
| Gross Weight | | 31.5kg |

Discharge Constant Current per Cell (Amperes at 77°F25°C)

| F.V/Time | 5min | 10min | 15min | 30min | 45min | 1h | 2h | 3h | 5h | 8h | 10h | 20h |
|----------|-------|-------|-------|-------|-------|-------|------|------|------|------|------|-------|
| 1.60V | 534.6 | 340.8 | 289.6 | 184.9 | 135.9 | 124.7 | 79.5 | 55.7 | 37.9 | 24.9 | 22.3 | 12.4 |
| 1.65V | 524.9 | 334.6 | 284.3 | 181.5 | 133.4 | 122.5 | 78.0 | 54.7 | 37.2 | 24.5 | 21.9 | 12.1 |
| 1.70V | 515.2 | 328.4 | 279.0 | 178.2 | 130.9 | 120.2 | 76.6 | 53.7 | 36.5 | 24.0 | 21.5 | 11.9 |
| 1.75V | 505.4 | 322.2 | 273.8 | 174.8 | 128.5 | 117.9 | 75.2 | 52.7 | 35.8 | 23.6 | 21.1 | 11.7 |
| 1.80V | 486.0 | 309.8 | 263.3 | 168.1 | 123.5 | 113.4 | 72.3 | 50.6 | 34.4 | 22.7 | 20.3 | 11.25 |

Discharge Constant Power per Cell (Watts at 77°F 25°C)

| F.V/Time | 5min | 10min | 15min | 30min | 45min | 1h | 2h | 3h | 5h | 8h | 10h | 20h |
|----------|--------|-------|-------|-------|-------|-------|-------|-------|------|------|------|------|
| 1.60V | 1029.1 | 656.1 | 557.4 | 355.9 | 261.6 | 240.1 | 153.0 | 107.2 | 72.9 | 48.0 | 42.9 | 23.8 |
| 1.65V | 1010.4 | 644.1 | 547.3 | 349.4 | 256.8 | 235.8 | 150.2 | 105.2 | 71.6 | 47.2 | 42.1 | 23.4 |
| 1.70V | 991.7 | 632.2 | 537.2 | 343.0 | 252.1 | 231.4 | 147.5 | 103.3 | 70.2 | 46.3 | 41.3 | 23.0 |
| 1.75V | 973.0 | 620.3 | 527.0 | 336.5 | 247.3 | 227.0 | 144.7 | 101.4 | 68.9 | 45.4 | 40.5 | 22.5 |
| 1.80V | 935.6 | 596.4 | 506.8 | 323.5 | 237.8 | 218.3 | 139.1 | 97.5 | 66.3 | 43.7 | 39.0 | 21.7 |

Note The above data are average values, and can be obtained within 3 charge/discharge cycles. These are not minimum values. Cell and battery designs/specifications are subject to modification without notice. Contact **US** for the latest information.

Performance Characteristics

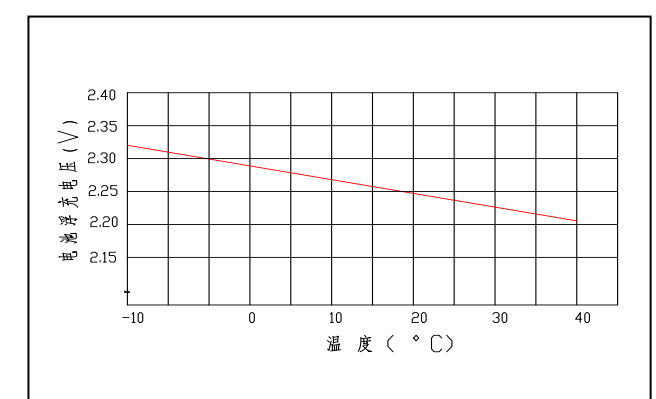
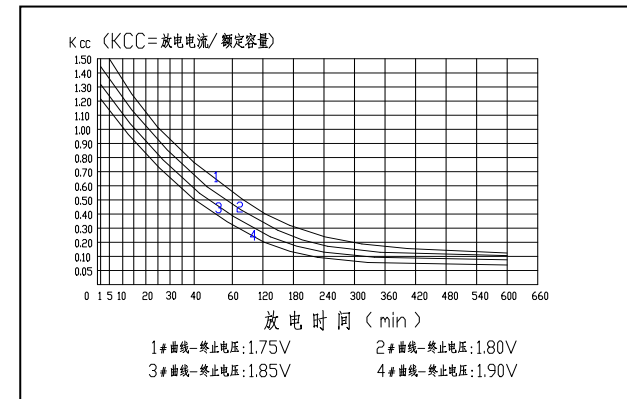
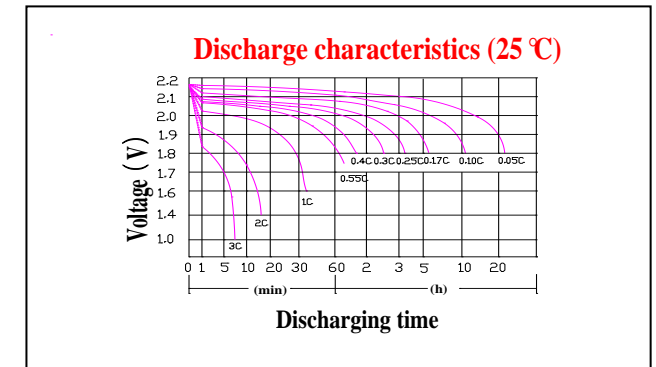
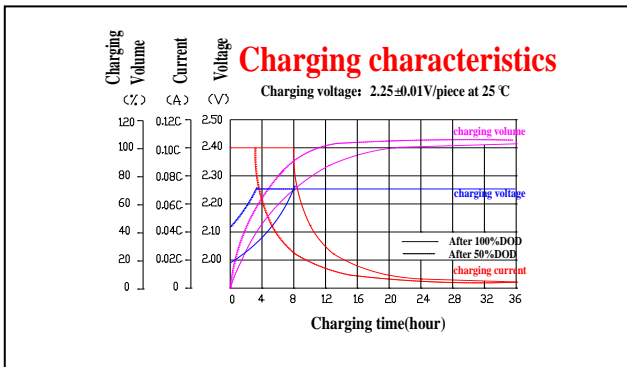
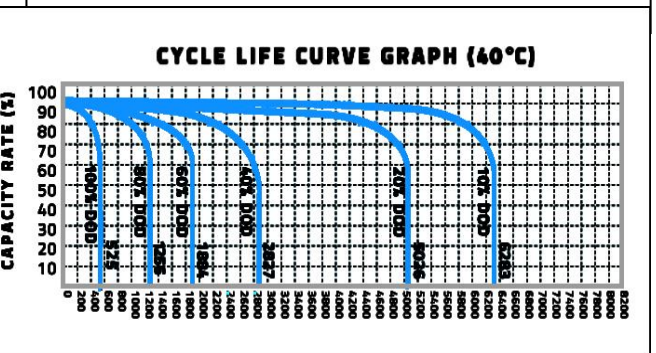
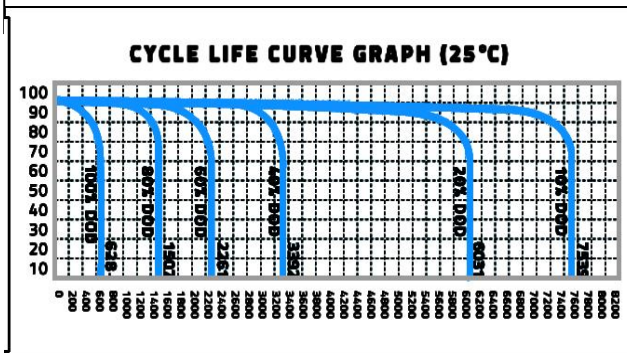
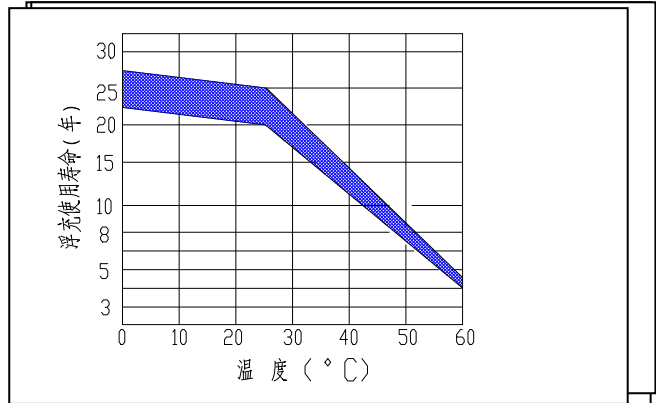
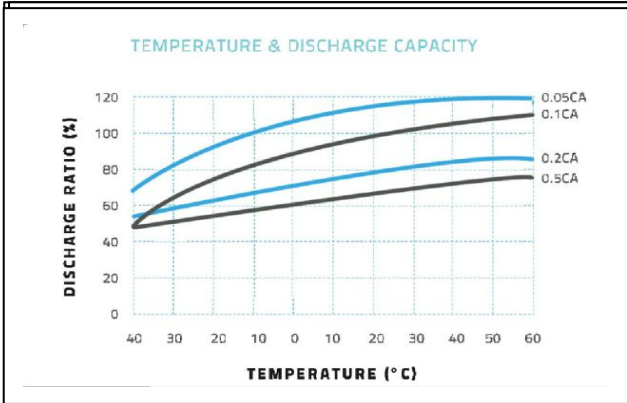

Battery Construction

| | | | | | | | | |
|--------------|----------------|----------------|-----------|-------|--------------|----------|------------|-------------|
| Component | Positive plate | Negative plate | Container | Cover | Safety valve | Terminal | Separator | Electrolyte |
| Raw material | Lead dioxide | Lead | ABS | ABS | Si-Rubber | Copper | Fiberglass | Silicon |