

Product Image

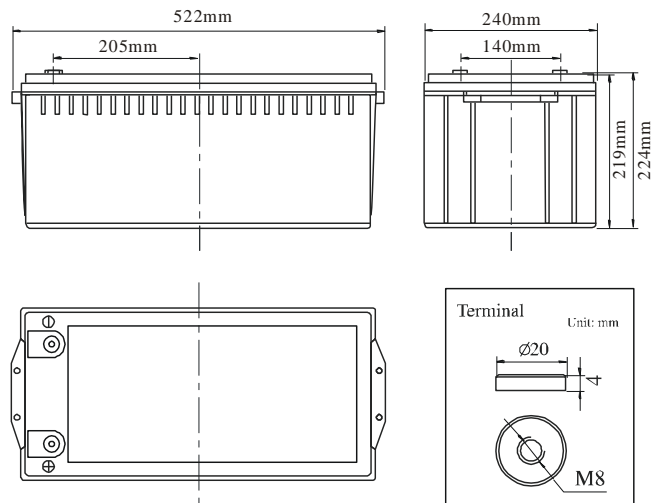

Product Dimensions



Characteristics

Nominal Voltage		12V
Nominal Capacity (10 hour rate)		220Ah
Capacity 25°C (77 °F)	20 hour rate (12.2A)	244.2Ah
	5 hour rate (40.3A)	201.3Ah
	1 hour rate (146.3A)	146.3Ah
Internal Resistance	Full Charged Battery 25°C	≤2.5mΩ
Capacity affected by Temperature (10 hour)	40°C (104 °F)	102%
	25°C (77 °F)	100%
	0°C (32 °F)	85%
	-15°C (5 °F)	65%
Self-Discharge 25°C (77 °F) Capacity	after 3 month storage	90%
	after 6 month storage	80%
	after 12 month storage	62%
Charge (Constant Voltage) 25°C (77 °F)	Float	Initial Charging Current Less than 40A Voltage 13.6-13.8V
	Cycle	Initial Charging Current Less than 40A Voltage 14.4-14.9V

Packaging

Battery Dimensions	Length	522mm
	Width	240mm
	Height	219mm
	Total Height	224mm
Box Dimensions	Length	537mm
	Width	255mm
	Height	299mm
Quantity Per Box		1 PC per box
Net weight Per Cell		60.0 kg ±500g
Net weight Per Box		60.0kg
Gross Weight		60.8kg

Discharge Constant Current per Cell (Amperes at 77°F/25°C)

F.V/Time	5min	10min	15min	30min	45min	1h	2h	3h	5h	8h	10h	20h
1.60V	693.5	462.0	371.4	209.9	150.6	133.1	89.2	65.2	42.0	25.6	22.9	12.13
1.65V	682.0	454.3	356.0	204.3	146.5	129.5	87.6	64.0	41.4	25.4	22.7	12.01
1.70V	647.3	431.2	340.5	198.7	142.5	125.9	85.9	62.8	40.8	25.1	22.4	11.89
1.75V	612.6	408.1	325.0	193.1	138.5	122.4	83.9	61.3	40.2	24.9	22.2	11.78
1.80V	577.9	385.0	309.5	187.4	134.4	118.8	81.8	59.8	39.6	24.6	22.0	11.66

Discharge Constant Power per Cell (Watts at 77°F 25°C)

F.V/Time	5min	10min	15min	30min	45min	1h	2h	3h	5h	8h	10h	20h
1.60V	1335.0	889.4	715.0	404.1	289.8	256.1	171.7	125.6	80.8	49.3	44.0	23.3
1.65V	1312.8	874.5	685.2	393.3	282.0	249.3	168.6	123.3	79.7	48.9	43.6	23.1
1.70V	1246.0	830.1	655.5	382.5	274.3	242.4	165.4	121.0	78.5	48.4	43.2	22.9
1.75V	1179.3	785.6	625.7	371.6	266.5	235.6	161.5	118.1	77.4	47.9	42.8	22.7
1.80V	1112.5	741.1	595.9	360.8	258.8	228.7	157.5	115.2	76.2	47.4	42.4	22.4

Note The above data are average values, and can be obtained within 3 charge/discharge cycles. These are not minimum values. Cell and battery designs/specifications are subject to modification without notice. Contact **US** for the latest information.

Performance Characteristics

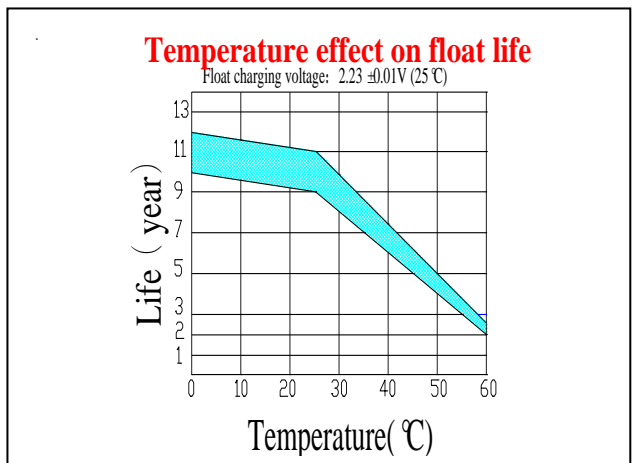
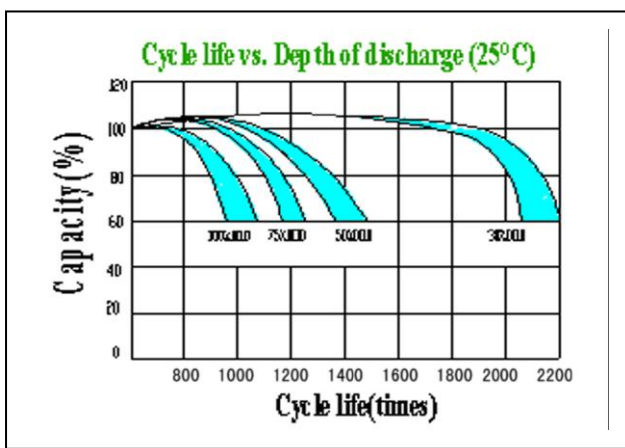
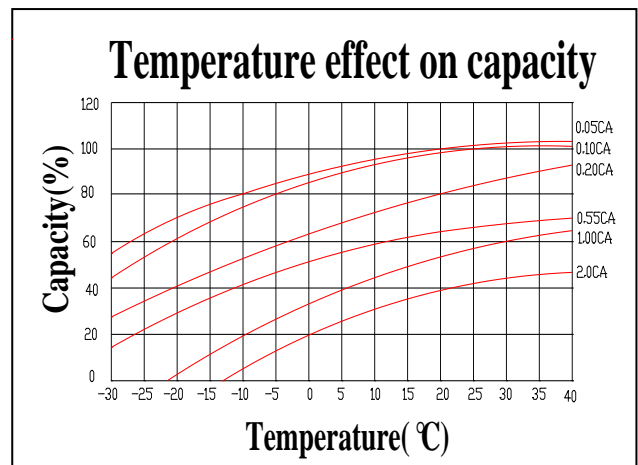
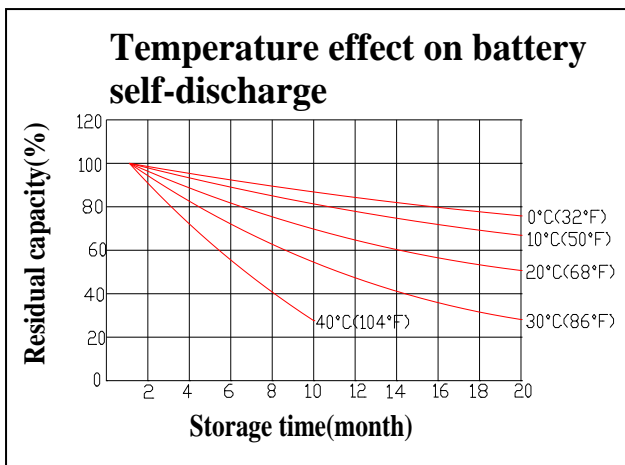
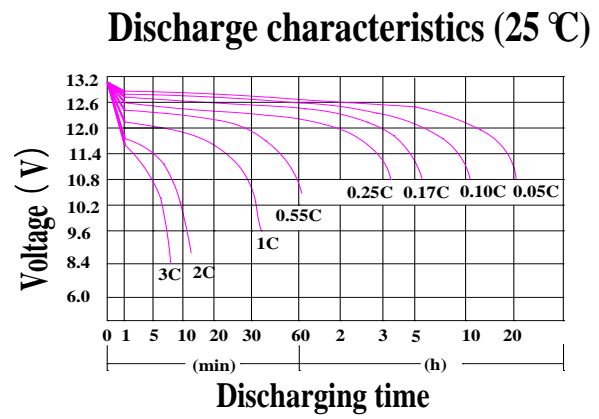
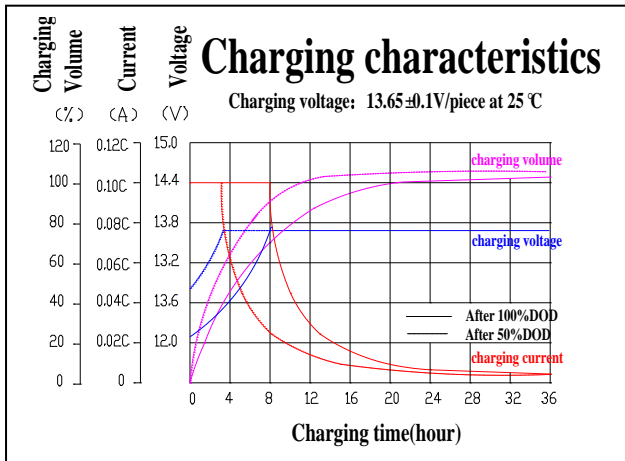

Battery Construction

Component	Positive plate	Negative plate	Container	Cover	Safety valve	Terminal	Separator	Electrolyte
Raw material	Lead dioxide	Lead	ABS	ABS	Si-Rubber	Lead	Fiberglass	Colloid(GEL)

Guangzhou Hengda Battery Co.,Ltd

Tel: 020-84866132 02084866098 Fax: 020-84869892
021-52811136; 021-52826931; 021-52826931-19