

Product Image

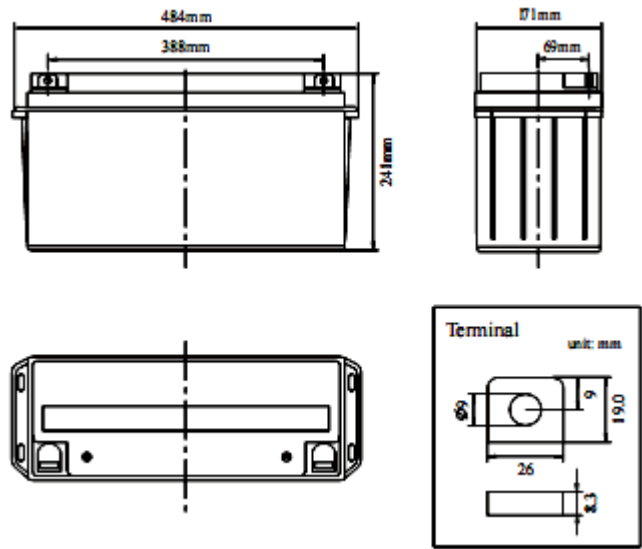

Product Dimensions



Characteristics

| | | |
|---|---------------------------|--|
| Nominal Voltage | | 12V |
| Nominal Capacity (10 hour rate) | | 200Ah |
| Capacity 25°C (77 F) | 20 hour rate (11.1A) | 222Ah |
| | 5 hour rate (36.6A) | 183Ah |
| | 1 hour rate (133A) | 133Ah |
| Internal Resistance | Full Charged Battery 25°C | ≤2.5mΩ |
| Capacity affected by Temperature (10 hour) | 40°C (104 F) | 102% |
| | 25°C (77 F) | 100% |
| | 0°C (32 F) | 85% |
| | -15°C (5 F) | 65% |
| Self-Discharge 25°C (77 F) Capacity | after 3 month storage | 90% |
| | after 6 month storage | 80% |
| | after 12 month storage | 62% |
| Charge (Constant Voltage) 25°C (77 F) | Float | Initial Charging Current Less than 50A Voltage 13.6-13.8V |
| | Cycle | Initial Charging Current Less than 50A Voltage 14.4-14.9V |

Packaging

| | | |
|-----------------------|------------------|--------------|
| Battery Dimensions | Length | 484mm |
| | Width | 171mm |
| | Height | 241mm |
| | Total Height | 241mm |
| Box Dimensions | Length | 499mm |
| | Width | 185mm |
| | Height | 299mm |
| | Quantity Per Box | 1 PC per box |
| Net weight Per Cell | | 53.5 kg±400g |
| Net weight Per Box | | 53.5kg |
| Gross Weight | | 54.0kg |

Discharge Constant Current per Cell (Amperes at 77°F25°C)

| F.V/Time | 5min | 10min | 15min | 30min | 45min | 1h | 2h | 3h | 5h | 8h | 10h | 20h |
|----------|-------|-------|-------|-------|-------|------|------|------|------|------|------|-----|
| 1.60V | 380.0 | 236.4 | 196.0 | 138.4 | 99.3 | 88.3 | 54.6 | 37.4 | 25.4 | 16.8 | 15.0 | 8.2 |
| 1.65V | 373.1 | 232.1 | 192.4 | 135.9 | 97.5 | 86.7 | 53.6 | 36.7 | 25.0 | 16.5 | 14.7 | 8.1 |
| 1.70V | 366.2 | 227.8 | 188.8 | 133.3 | 95.7 | 85.1 | 52.6 | 36.0 | 24.5 | 16.1 | 14.4 | 7.9 |
| 1.75V | 359.3 | 223.5 | 185.3 | 130.8 | 93.9 | 83.4 | 51.6 | 35.4 | 24.0 | 15.8 | 14.1 | 7.8 |
| 1.80V | 345.4 | 214.9 | 178.2 | 125.8 | 90.3 | 80.2 | 49.6 | 34.0 | 23.1 | 15.2 | 13.6 | 7.5 |

Discharge Constant Power per Cell (Watts at 77°F 25°C)

| F.V/Time | 5min | 10min | 15min | 30min | 45min | 1h | 2h | 3h | 5h | 8h | 10h | 20h |
|----------|-------|-------|-------|-------|-------|-------|-------|------|------|------|------|------|
| 1.60V | 731.5 | 455.0 | 377.3 | 266.4 | 191.2 | 169.9 | 105.1 | 72.0 | 49.0 | 32.3 | 28.8 | 15.8 |
| 1.65V | 718.2 | 446.7 | 370.4 | 261.5 | 187.7 | 166.8 | 103.2 | 70.7 | 48.1 | 31.7 | 28.3 | 15.6 |
| 1.70V | 704.9 | 438.5 | 363.5 | 256.7 | 184.3 | 163.7 | 101.3 | 69.4 | 47.2 | 31.1 | 27.8 | 15.3 |
| 1.75V | 691.6 | 430.2 | 356.7 | 251.9 | 180.8 | 160.6 | 99.4 | 68.1 | 46.3 | 30.5 | 27.2 | 15.0 |
| 1.80V | 665.0 | 413.6 | 343.0 | 242.2 | 173.8 | 154.5 | 95.6 | 65.5 | 44.5 | 29.3 | 26.2 | 14.4 |

Note The above data are average values, and can be obtained within 3 charge/discharge cycles. These are not minimum values. Cell and battery designs/specifications are subject to modification without notice. Contact **US** for the latest information.

Performance Characteristics

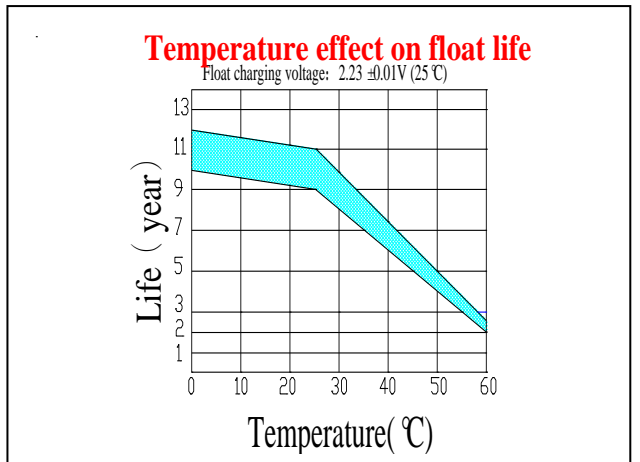
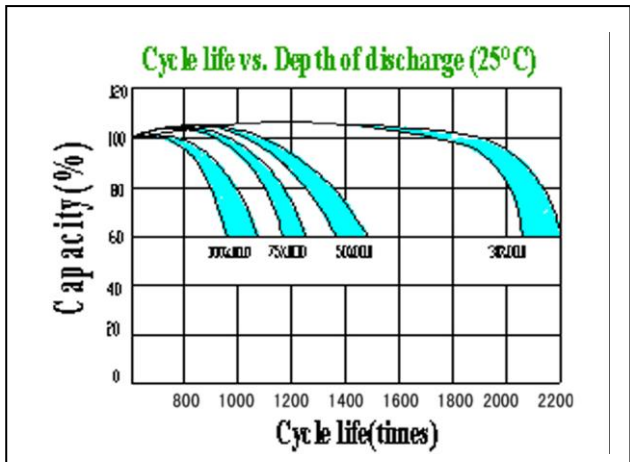
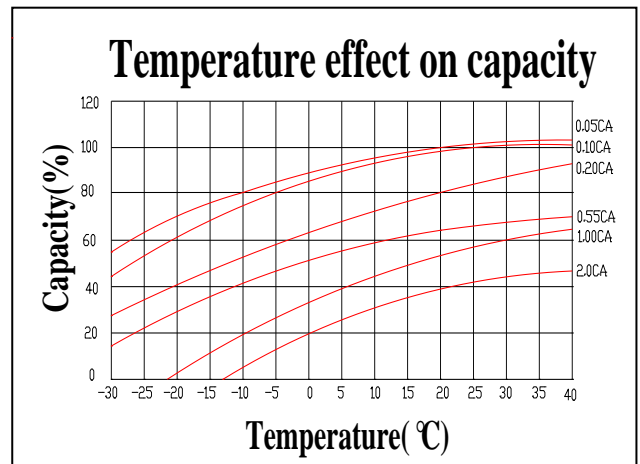
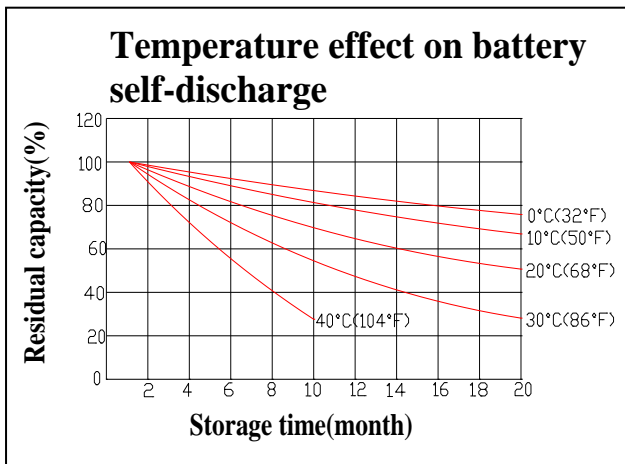
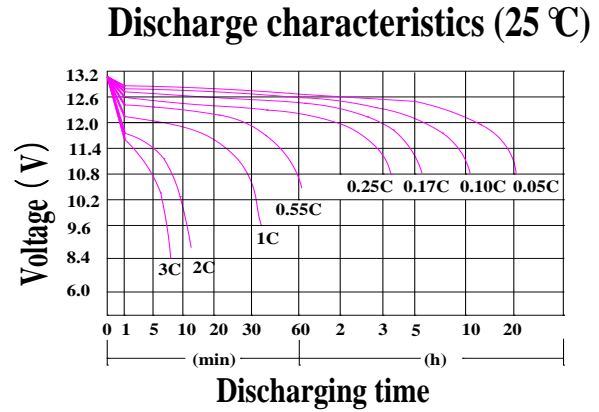
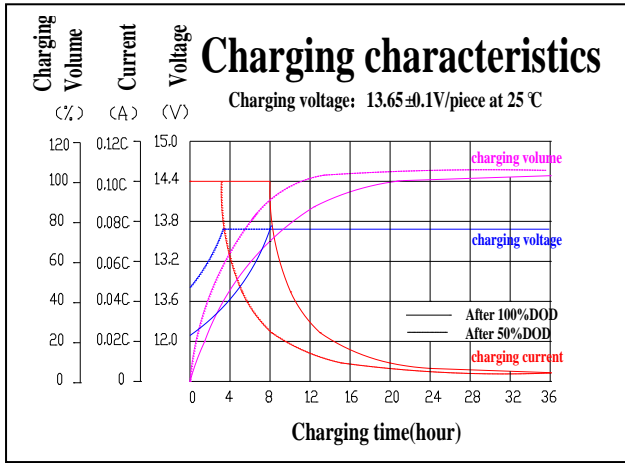

Battery Construction

| Component | Positive plate | Negative plate | Container | Cover | Safety valve | Terminal | Separator | Electrolyte |
|--------------|----------------|----------------|-----------|-------|--------------|----------|------------|---------------|
| Raw material | Lead dioxide | Lead | ABS | ABS | Si-Rubber | Lead | Fiberglass | Sulfuric acid |