

**Product Image**

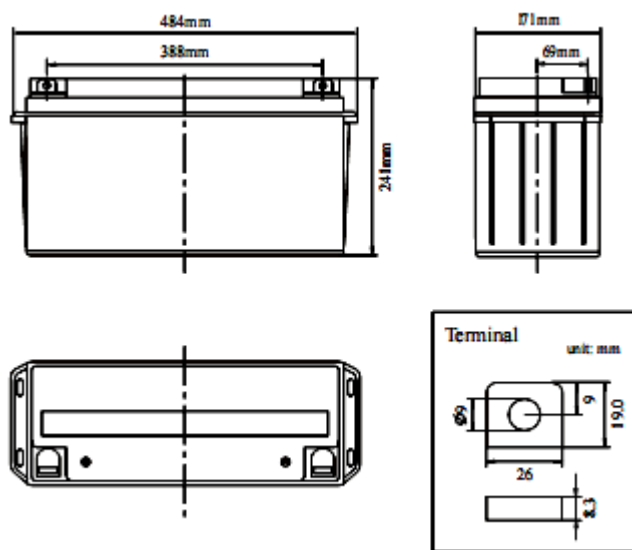

**Product Dimensions**



**Characteristics**

Nominal Voltage		12V
Nominal Capacity (20 hour rate)		160Ah
Capacity 25°C (77 °F)	20 hour rate (8.9A)	177.6Ah
	5 hour rate (29.3A)	146.4Ah
	1 hour rate (106.4A)	106.4Ah
Internal Resistance	Full Charged Battery 25°C	≤3.5mΩ
Capacity affected by Temperature (10 hour )	40°C (104 °F)	102%
	25°C (77 °F)	100%
	0°C (32 °F)	85%
	-15°C (5 °F)	65%
Self-Discharge 25°C (77 °F) Capacity	after 3 month storage	90%
	after 6 month storage	80%
	after 12 month storage	62%
Charge (Constant Voltage) 25°C (77 °F)	Float	Initial Charging Current Less than 37.5A Voltage 13.6-13.8V
	Cycle	Initial Charging Current Less than 37.5A Voltage 14.4-14.9V

**Packaging**

Battery Dimensions	Length	484mm
	Width	171mm
	Height	241mm
	Total Height	241mm
Box Dimensions	Length	499mm
	Width	185mm
	Height	299mm
Quantity Per Box		1 PC per box
Net weight Per Cell		46.3 kg±400g
Net weight Per Box		46.3kg
Gross Weight		46.7kg

**Discharge Constant Current per Cell (Amperes at 77°F25°C)**

F.V/Time	5min	10min	15min	30min	45min	1h	2h	3h	5h	8h	10h	20h
1.60V	380.0	236.4	196.0	138.4	99.3	88.3	54.6	37.4	25.4	16.8	15.0	8.2
1.65V	373.1	232.1	192.4	135.9	97.5	86.7	53.6	36.7	25.0	16.5	14.7	8.1
1.70V	366.2	227.8	188.8	133.3	95.7	85.1	52.6	36.0	24.5	16.1	14.4	7.9
1.75V	359.3	223.5	185.3	130.8	93.9	83.4	51.6	35.4	24.0	15.8	14.1	7.8
1.80V	345.4	214.9	178.2	125.8	90.3	80.2	49.6	34.0	23.1	15.2	13.6	7.5

**Discharge Constant Power per Cell (Watts at 77°F 25°C)**

F.V/Time	5min	10min	15min	30min	45min	1h	2h	3h	5h	8h	10h	20h
1.60V	731.5	455.0	377.3	266.4	191.2	169.9	105.1	72.0	49.0	32.3	28.8	15.8
1.65V	718.2	446.7	370.4	261.5	187.7	166.8	103.2	70.7	48.1	31.7	28.3	15.6
1.70V	704.9	438.5	363.5	256.7	184.3	163.7	101.3	69.4	47.2	31.1	27.8	15.3
1.75V	691.6	430.2	356.7	251.9	180.8	160.6	99.4	68.1	46.3	30.5	27.2	15.0
1.80V	665.0	413.6	343.0	242.2	173.8	154.5	95.6	65.5	44.5	29.3	26.2	14.4

**Note** The above data are average values, and can be obtained within 3 charge/discharge cycles. These are not minimum values. Cell and battery designs/specifications are subject to modification without notice. Contact **US** for the latest information.

**Performance Characteristics**

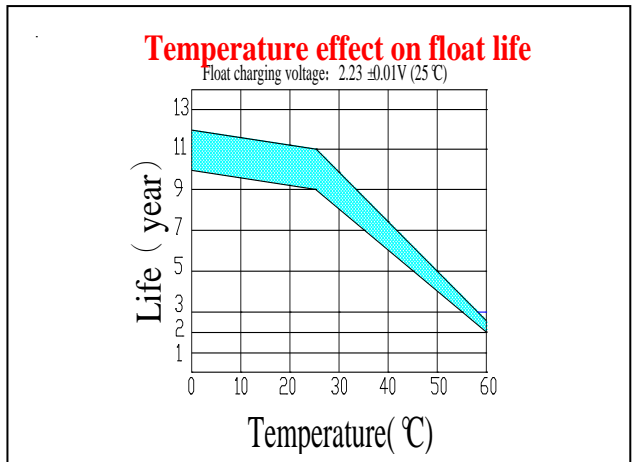
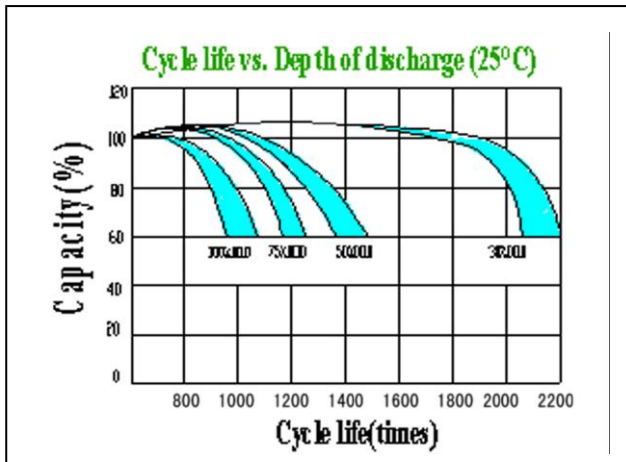
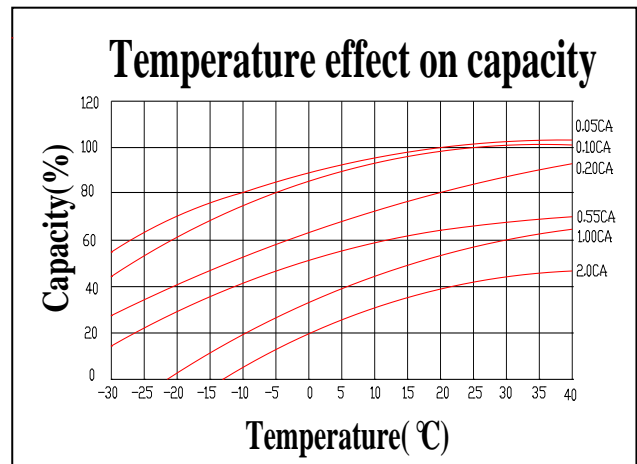
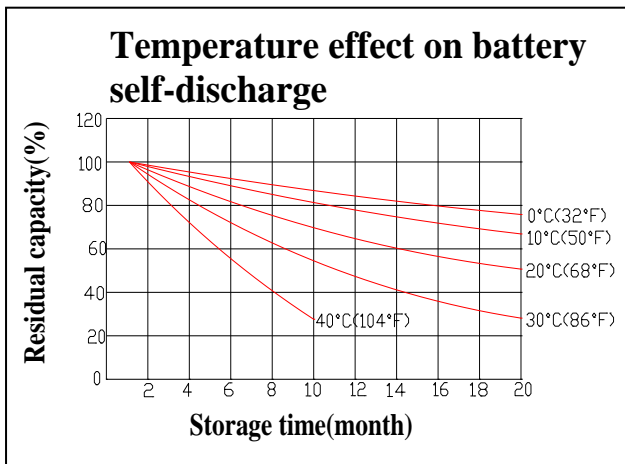
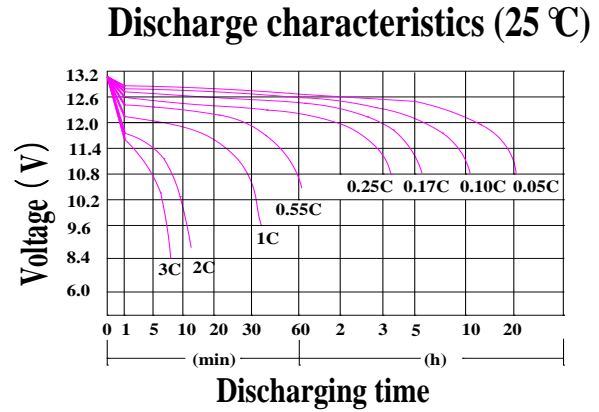

**Battery Construction**

Component	Positive plate	Negative plate	Container	Cover	Safety valve	Terminal	Separator	Electrolyte
Raw material	Lead dioxide	Lead	ABS	ABS	Si-Rubber	Lead	Fiberglass	Sulfuric acid